

HITACHI

INSTRUCTION MANUAL AND SAFETY INSTRUCTIONS FOR NAILER

MODEL VH-650 NV 50AA

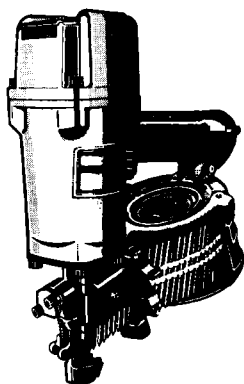

VH-650

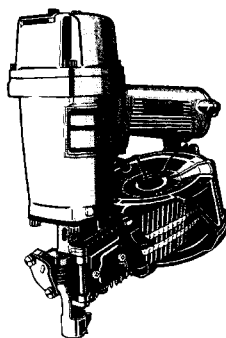

NV50AA

⚠ DANGER

Improper and unsafe use of this Nailer will result in death or serious injury!
This Manual contains important information about product safety.
Read and understand this Manual before operating the Nailer.
Keep this Manual available for others before they use the Nailer.

— CONTENTS —

	Page
IMPORTANT INFORMATION	3
DEFINITIONS OF SIGNAL WORDS	3
 SAFETY	
IMPORTANT SAFETY INSTRUCTIONS FOR USING NAILERS	4
IMPORTANT SAFETY INSTRUCTIONS FOR USING VH-650 • NV50AA COIL NAILER	6
EMPLOYER'S RESPONSIBILITIES	6
 OPERATION	
NAME OF PARTS	7
SPECIFICATIONS	8
NAIL SELECTION	8
ACCESSORIES	8
STANDARD ACCESSORIES	8
OPTIONAL ACCESSORIES	9
APPLICATIONS	9
BEFORE OPERATION	9
WORKING ENVIRONMENT	9
AIR SUPPLY	9
LUBRICATION	10
COLD WEATHER CARE	10
TESTING THE NAILER	10
ADJUSTING AIR PRESSURE	11
LOADING NAILS	11
NAILER OPERATION	12
METHODS OF OPERATION	12
 MAINTENANCE	
MAINTENANCE AND INSPECTION	14
SERVICE AND REPAIRS	14
PARTS LIST	16

IMPORTANT INFORMATION

READ AND UNDERSTAND ALL OF THE OPERATING INSTRUCTIONS, SAFETY PRECAUTIONS AND WARNINGS IN THE INSTRUCTION MANUAL BEFORE OPERATING OR MAINTAINING THIS NAILER.

Most accidents that result from the operation and maintenance of Nailers are caused by the failure to observe basic safety rules or precautions. An accident can often be avoided by recognizing a potentially hazardous situation before it occurs, and by observing appropriate safety procedures.

Basic safety precautions are outlined in the "SAFETY" section of this Instruction Manual and in the sections which contain the operation and maintenance instructions.

Hazards that must be avoided to prevent bodily injury or machine damage are identified by DANGERS and WARNINGS on the Nailer and in this Instruction Manual.

Never use this Nailer for applications other than those specified in this Instruction Manual.

DEFINITIONS OF SIGNAL WORDS

DANGER indicates an imminently hazardous situation which, if not avoided, will result in death or serious injury.

WARNING indicates a potentially hazardous situation which, if not avoided, could result in death or serious injury.

CAUTION indicates a potentially hazardous situation which, if not avoided, may result in minor or moderate injury, or may cause machine damage.

NOTE emphasizes essential information.

SAFETY

IMPORTANT SAFETY INSTRUCTIONS FOR USING NAILERS

READ ALL INSTRUCTIONS

⚠ DANGER

1. ALWAYS WEAR EYE PROTECTOR.



When operating the Nailer, always wear eye protector, and make sure others in work area wear eye protector, too.

Eye protector must conform to the requirements of American National Standards Institute, ANSI Z87.1 and provide protection against flying particles both from the front and side.

The employer must enforce the use of eye protector by the Nailer operator and others in work area.

2. NEVER USE BOTTLED GASES.



Never use oxygen, combustible gases or any other bottled gases as a power source for the Nailer.

Use of the above gases is dangerous, as the Nailer will explode.

Use only clean, dry, regulated compressed air.

⚠ WARNING

3. DO NOT EXCEED 120 psi.

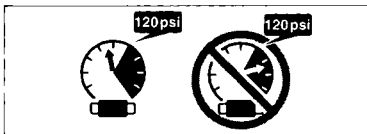

Do not exceed maximum recommended air pressure 120 psi (8.3 bar 8.5 kgf/cm²).

Never connect the Nailer to pressure which potentially exceeds 200 psi (13.7 bar 14 kgf/cm²) as the Nailer can burst.

4. NEVER POINT NAILER TOWARD YOURSELF OR ANYONE ELSE.

Always assume the Nailer contains fasteners. Never point the Nailer toward yourself or anyone else, whether it contains fasteners or not.

If fasteners are mistakenly driven, it can lead to severe injuries.

Never engage in horseplay with the Nailer. Respect the Nailer as a working implement.

5. NEVER CARRY WITH FINGER ON TRIGGER.

Remove finger from trigger when not driving fasteners.

Never carry the Nailer with finger on trigger since you could drive a fastener unintentionally and injure yourself or someone else.

Always carry the Nailer by the handle only.

6. ALWAYS WEAR EAR AND HEAD PROTECTOR.

Always wear ear protector to protect your ears from loud noise.

Always wear head protector to protect your head from flying objects.

7. STORE NAILER PROPERLY.

When not in use, the Nailer should be stored in a dry place. Keep out of reach of children. Lock the storage area.

8. KEEP WORK AREA CLEAN.

Cluttered areas invite injuries. Clear all work areas of unnecessary tools, debris, furniture, etc.

9. NEVER USE IN PRESENCE OF FLAMMABLE LIQUIDS OR GASES.

The Nailer produces sparks during operation. Never use the Nailer in sites containing lacquer, paint, benzine, thinner, gasoline, gases, adhesive agents, and other materials which are combustible or explosive.

10. KEEP VISITORS AWAY.

Do not let visitors handle the Nailer. All visitors should be kept safely away from work area.

11. DRESS PROPERLY.

Do not wear loose clothing or jewelry as they can be caught in moving parts.

Rubber gloves and nonskid footwear are recommended when working outdoors.

Wear protective hair covering to contain long hair.

12. NEVER USE NON RELIEVING COUPLER ON NAILER.

If a non relieving coupler is used on the Nailer, the Nailer can remain charged with air after disconnecting and thus will be able to drive a fastener even after disconnecting.

The Nailer and air hose must have a hose coupling such that all pressure is removed from the Nailer when the coupling joint is disconnected.

13. CHECK PUSH LEVER BEFORE URE.

Make sure the push lever operates properly. (The push lever may be called "Safety".) Never use the Nailer unless the push lever is operating properly, otherwise the Nailer could drive a fastener unexpectedly. Do not tamper with or remove the push lever, otherwise the push lever becomes inoperable.

14. KEEP ALL SCREWS AND COVERS TIGHTLY IN PLACE.

Keep all screws and covers tightly mounted. Check their condition periodically.

Never use the Nailer if parts are missing or damaged.

15. DO NOT LOAD FASTENERS WITH TRIGGER OR PUSH LEVER DEPRESSED.

When loading fasteners into the Nailer or when connecting the air hose,

- 1) do not depress the trigger;
- 2) do not depress the push lever; and
- 3) keep the Nailer pointed downward.

16. KEEP HANDS AND FEET AWAY FROM FIRING HEAD DURING USE.

Never place your hands or feet closer than 8 inches from the firing head.

A serious injury can result if the fasteners are deflected by the workpiece, or are driven away from the point of entry.

17. PLACE NAILER PROPERLY ON WORKPIECE.

Do not drive fasteners on top of other fasteners or with the Nailer at too steep of an angle; the fasteners can ricochet and hurt someone.

18. TAKE CARE OF DOUBLE FIRE DUE TO RECOIL.

If the push lever is unintentionally allowed to re-contact the workpiece following recoil, an unwanted fastener will be driven.

In order to avoid this undesirable double fire,

- 1) do not push the Nailer on the workpiece with strong force;
- 2) take the Nailer completely away from the workpiece using recoil, and keep the push lever away from the workpiece until the next desirable shot; and
- 3) pull the trigger and release it QUICKLY when performing intermittent operation (trigger fire).

19. DO NOT DRIVE FASTENERS INTO THIN BOARDS OR NEAR CORNERS AND EDGES OF WORKPIECE.

The fasteners can be driven through or away from the workpiece and hit someone.

20. NEVER DRIVE FASTENERS FROM BOTH SIDES OF A WALL AT THE SAME TIME.

The fasteners can be driven into and through the wall and hit a person on the opposite side.

21. CHECK FOR LIVE WIRES.

Avoid the risk of severe electrical shock by checking for live electrical wires that may be hidden by walls, floors or ceilings. Turn off the breaker switch to ensure there are no live wires.

22. NEVER CARRY NAILER BY HOSE.

23. DO NOT OVERREACH.

Keep proper footing and balance at all times.

24. NEVER USE NAILER WHICH IS DEFECTIVE OR OPERATING ABNORMALLY.

If the Nailer appears to be operating unusually, making strange noises, or otherwise appears defective, stop using it immediately and arrange for repairs by a Hitachi authorized service center.

25. DO NOT DISCONNECT AIR HOSE FROM NAILER WITH FINGER ON TRIGGER.

The Nailer can fire when re-connected to an air supply.

SAFETY — Continued

26. DISCONNECT AIR HOSE FROM NAILER WHEN:

- 1) doing maintenance and inspection;
- 2) clearing a jam;
- 3) it is not in use;
- 4) leaving work area;
- 5) moving it to another location; and
- 6) handing it to another person.

Never attempt to clear a jam or repair the Nailer unless you have disconnected air hose from the Nailer and removed all remaining fasteners from the Nailer. The Nailer should never be left unattended since people who are not familiar with the Nailer might handle it and injure themselves.

27. STAY ALERT.

Watch what you are doing. Use common sense. Do not operate the Nailer when you are tired. The Nailer should never be used by you if you are under the influence of alcohol, drugs or medication that makes you drowsy.

28. HANDLE NAILER CORRECTLY.

Operate the Nailer according to this Manual. Never allow the Nailer to be operated by children, individuals unfamiliar with its operation or unauthorized personnel.

29. NEVER USE NAILER FOR APPLICATIONS OTHER THAN THOSE SPECIFIED IN THIS MANUAL.

30. HANDLE NAILER CAREFULLY

Because of high air pressure in the Nailer, cracks in the surface are dangerous.

To avoid this, do not drop the Nailer or strike the Nailer against hard surfaces; and do not scratch or engrave signs on the Nailer. Handle the Nailer carefully.

31. MAINTAIN NAILER WITH CARE.

Keep the Nailer clean and lubricated for better and safer performance.

32. USE ONLY PARTS, ACCESSORIES OR FASTENERS SUPPLIED OR RECOMMENDED BY HITACHI.

Unauthorized parts, accessories, or fasteners may void your warranty and can lead to malfunction and resulting injuries.

Only service personnel trained by Hitachi, distributor or employer shall repair the Nailer.

Do not modify the Nailer without the written approval of Hitachi.

IMPORTANT SAFETY INSTRUCTIONS FOR USING VH-650 · NV50AA COIL NAILER

WARNING

1. CLOSE NAIL GUIDE AND DO NOT OPEN IT DURING OPERATION.

If driving fasteners with the nail guide open, the fasteners can be driven away from the workpiece.

2. DO NOT OPEN MAGAZINE FACING DOWNWARD WHILE LOADING FASTENERS.

The fasteners can fall down and result in personal injury.

EMPLOYER'S RESPONSIBILITIES

1. Ensure that this INSTRUCTION MANUAL is available to operators and personnel performing maintenance.
2. Ensure that Nailers are used only when operators and others in work area are wearing EYE PROTECTOR.
3. Enforce the use of EYE PROTECTOR by operators and others in work area.

4. Keep Nailers in safe working order.
5. Maintain Nailers properly.
6. Ensure that Nailers which require repair are not further used before repair.

SAVE THIS MANUAL AND KEEP IT AVAILABLE FOR OTHERS!

OPERATION

NOTE:

The information contained in this Manual is designed to assist you in the safe operation of the Nailer.

Some illustrations in this Manual may show details or attachments that differ from those on your own Nailer.

NAME OF PARTS

<VH-650>

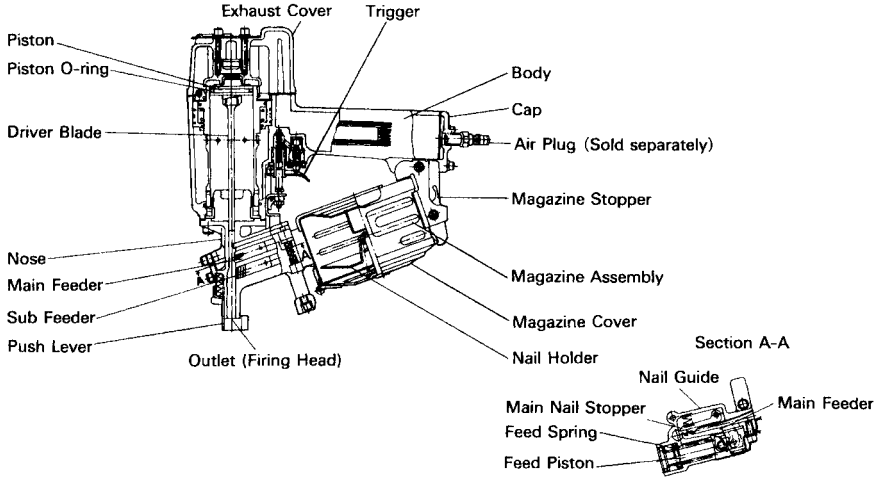

<NV50AA>

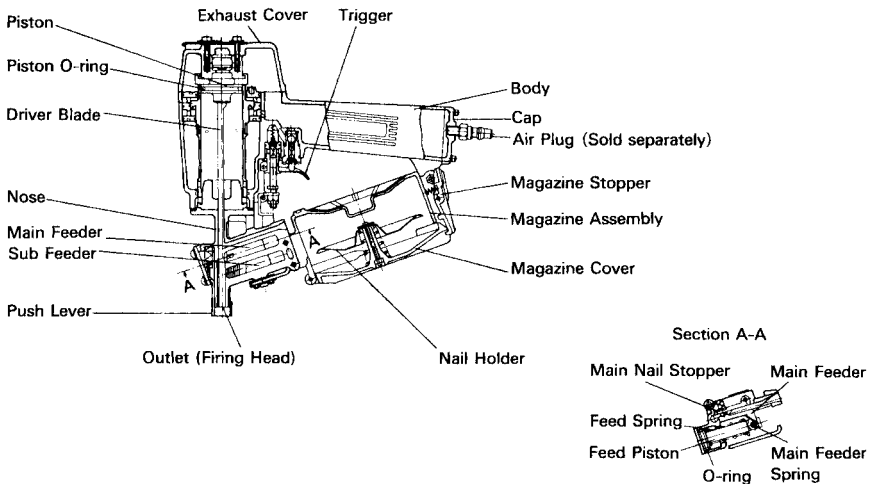

SPECIFICATIONS

Model	VH-650	NV50AA
Operating pressure	70—120 psi(4.9—8.3 bar 5—8.5 kgf/cm ²)	
Dimensions Length×Height×Width	10-11/32"×11-3/32"×4-13/16" (263mm×282mm×122mm)	9-27/32"×9-13/16"×5-3/32" (250mm×249mm×129mm)
Weight	6.6 lbs(3 kg)	4.2 lbs(1.9 kg)
Nail capacity	300—385 nails(1 coil)	385 nails(1 coil)
Air consumption	.047 ft ³ /cycle at 100 psi (1.3 ltr/cycle at 6.9 bar) (1.3 ltr/cycle at 7 kgf/cm ²)	.035 ft ³ /cycle at 100 psi (.99 ltr/cycle at 6.9 bar) (.99 ltr/cycle at 7 kgf/cm ²)
Air inlet	3/8 NPT Thread	

NAIL SELECTION

Only nails shown in the Table below can be driven with this Nailer.
Nails are collated and coiled, as shown in the right figure.

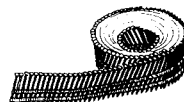

Plastic-collated coil nails

Dimensions of nails

VH-650		NV50AA	
Min.	Max.	Min.	Max.
.215" (5.5 mm)	.245" (6.2 mm)	.228" (5.8 mm)	.288" (5.8 mm)
1-1/2" (38 mm)	2-1/2" (65 mm)	1-1/4" (32 mm)	2" (50 mm)
.083" (2.1 mm)	.099" (2.5 mm)	.083" (2.1 mm)	.083" (2.1 mm)

ACCESSORIES

⚠ WARNING

- Accessories other than those shown below can lead to malfunction and resulting injuries.

STANDARD ACCESSORIES

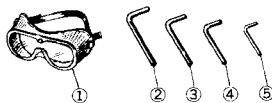

Model	VH-650	NV50AA
① Eye protector	1	1
② Allen wrench for M6 screw	1	
③ Allen wrench for M5 screw	1	
④ Allen wrench for M4 screw		1
⑤ Allen wrench for M3 screw		1

OPTIONAL ACCESSORIES

...sold separately

- Pneumatic Tool Lubricant
.8 oz. (25 cc) oil feeder (Code No. 877153)
4 oz. (120 cc) oil feeder (Code No. 874042)
1 quart (1 ltr) can (Code No. 876212)

NOTE: Accessories are subject to change without any obligation on the part of HITACHI.

APPLICATIONS

- Construction work such as wall sheathing, roof decking, subflooring.
- Mobile and modular home construction.

BEFORE OPERATION

Read section titled "SAFETY" (pages 4–6).

Make sure of the followings before operation.

WORKING ENVIRONMENT

⚠ WARNING

- No flammable gas, liquid or other flammable objects at worksite.
- Clear the area of children or unauthorized personnel.

AIR SUPPLY

⚠ DANGER



- Never use oxygen, combustible gases or any other bottled gases.

⚠ WARNING

- Never connect Nailer to pressure which potentially exceeds 200 psi (13.7 bar 14 kgf/cm²).
- Never use non relieving coupler on Nailer.

1. Power source

- Use only clean, dry, regulated compressed air as a power source for this Nailer.

- Air compressors used to supply compressed air to this Nailer must comply with the requirements of the latest version of ANSI Standard B19.3 "Safety Standard For Compressors For Process Industries."
- Moisture or oil in the air compressor may accelerate wear and corrosion in the Nailer. Drain daily.

2. Filter-Regulator-Lubricator

- Use a regulator with a pressure range of 0–120 psi (0–8.3 bar 0–8.5 kgf/cm²).
- Filter-regulator-lubricator units supply an optimum condition for the Nailer and extend the Nailer life. These units should always be used.
 - FilterThe filter removes moisture and dirt mixed in compressed air. Drain daily unless fitted with an automatic drain. Keep the filter clean by regular maintenance.
 - RegulatorThe regulator controls the operating pressure for safe operation of the Nailer. Inspect the regulator before operation to be sure it operates properly.
 - LubricatorThe lubricator supplies an oil mist to the Nailer. Inspect the lubricator before operation to be sure the supply of lubricant is adequate. Use Hitachi pneumatic tool lubricant.

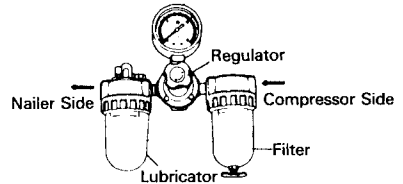

3. Air hose

Air hose must have a minimum working pressure rating of 150 psi (10.4 bar 10.6 kgf/cm²) or 150% of the maximum pressure produced in the system, whichever is higher.

4. Hose coupling

- The Nailer can be installed as follows: Remove the dust seal placed at the air inlet. Install a 3/8 NPT male plug at the air inlet.

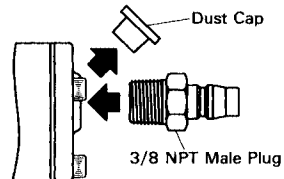

- A female coupler must be on the air hose. The hose coupling (male plug—female coupler) must remove all pressure from the Nailer when disconnected. Never use a non relieving coupler on the Nailer.

5. Air consumption

Using the Air consumption table and the Air compressor size formula, find a correct compressor size.

Air consumption table

		80	90	100
Operating pressure		(5.5)	(6.2)	(6.9)
(kgf/cm ²)		(5.6)	(6.3)	(7)
Air consumption	VH-650	.029 (.82)	.038 (1.1)	.047 (1.3)
	NV50AA	.025 (.71)	.030 (.85)	.035 (.99)

Air compressor size formula

Amount of air required

= number of Nailers

× average nails driven each minute per Nailer

× air consumption at given air pressure

× safety factor (always 1.2)

Example: 2 Nailers (VH-650) operating at 100 psi driving 30 nails per minute

Amount of air required

= $2 \times 30 \times .047 (1.3) \times 1.2$

= 3.4 CFM (ft³/min) (94 ltr/min)

After making the calculations as shown above, you should find a compressor providing 3.4 CFM of air that is required.

LUBRICATION

It is important that the Nailer be properly lubricated. Without proper lubrication, the Nailer will not work properly and parts will wear prematurely.

- Use Hitachi pneumatic tool lubricant. Do not use detergent oil or additives. These lubricants will harm the O-rings and other rubber parts. This will cause the Nailer to malfunction.
- Filter-regulator-lubricator units should always be used. Keep the lubricator filled with Hitachi pneumatic tool lubricant.
- If a lubricator is not available, supply 2—3 drops of Hitachi pneumatic tool lubricant into the air plug on the Nailer twice a day.

COLD WEATHER CARE

- Do not store the Nailer in a cold weather environment. Keep the Nailer in a warm area until beginning the work.
- If the Nailer is already cold, bring it in a warm area and allow the Nailer to warm up before use.
 - ① Reduce the air pressure to 40 psi (2.8 bar 2.8 kgf/cm²).
 - ② Remove all nails from the Nailer.
 - ③ Connect the air hose and free-fire (blank-fire) the Nailer. The lowered air pressure will be enough to free-fire the Nailer. Slow speed operation tends to warm up the moving part.

CAUTION

- Do not free-fire the Nailer at high pressure.

TESTING THE NAILER

⚠ DANGER



- Always wear eye protector.

⚠ WARNING

- Never use Nailer unless push lever is operating properly.

Before actually beginning the nailing work, test the Nailer by using the checklist below. Conduct the tests in the following order.

If abnormal operation occurs, stop using the Nailer and contact a Hitachi authorized service center immediately.

- (1) DISCONNECT AIR HOSE FROM NAILER.
REMOVE ALL NAILS FROM NAILER.

- ALL SCREWS MUST BE TIGHTENED.
If any screws are loose, tighten them.

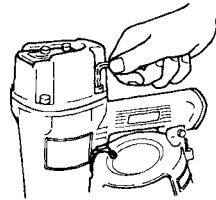

- THE PUSH LEVER AND TRIGGER MUST MOVE SMOOTHLY.

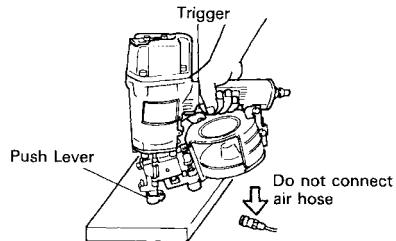

- (2) Adjust the air pressure to 70 psi (4.9 bar 5 kgf/cm²).
Connect the air hose.
Do not load any nails in the Nailer.

- THE NAILER MUST NOT LEAK AIR.

Hold the Nailer downward and pull the trigger.

THE NAILER MUST NOT OPERATE.

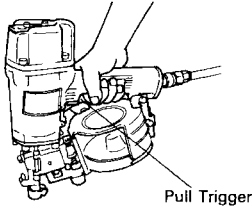

(3) With finger off the trigger, depress the push lever against the workpiece.

THE NAILER MUST NOT OPERATE.

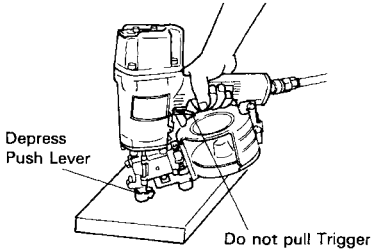

(4) Without touching the trigger, depress the push lever against the workpiece. Pull the trigger.

THE NAILER MUST OPERATE.

(5) With the Nailer off the workpiece, pull the trigger. Depress the push lever against the workpiece.

THE NAILER MUST OPERATE.

(6) If no abnormal operation is observed, you may load nails in the Nailer. Drive nails into the workpiece that is the same type to be used in the actual application.

THE NAILER MUST OPERATE PROPERLY.

ADJUSTING AIR PRESSURE

⚠ WARNING

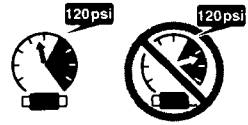

● Do not exceed 120 psi (8.3 bar 8.5 kgf/cm²).

Adjust the air pressure at recommended operating pressure 70–120 psi (4.9–8.3 bar 5–8.5 kgf/cm²) according to the length of nails and the hardness of workpiece.

The correct air pressure is the lowest pressure which will do the job. Using the Nailer at a higher than required air pressure unnecessarily over stresses the Nailer.

LOADING NAILS

⚠ WARNING

- When loading nails into Nailer,
 - 1) do not depress trigger;
 - 2) do not depress push lever; and
 - 3) keep Nailer pointed downward.

(1) Press the magazine stopper and open the magazine cover.

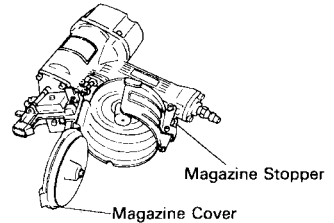

(2) Place the nail coil in the magazine. Insert the first nail into the magazine opening.

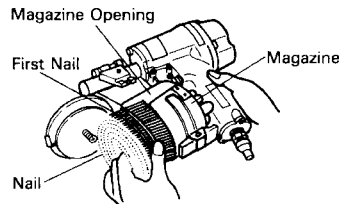

- (3) Close the magazine cover.
 (4) Grip the nail guide and knob with finger.
 Press down the knob and swing the nail guide open.

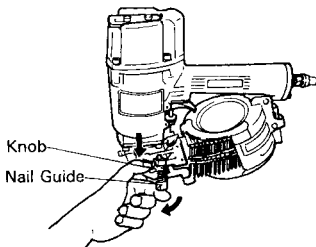

- (5) ① Uncoil enough nails to reach the main feeder.
 ② Insert the first nail between the two pawls of main feeder.
 ③ Fit the nail heads in the guide slot.

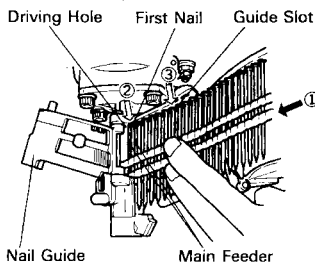

NOTE:

- Be careful not to insert the first nail into the driving hole. Otherwise, the nail guide will not close correctly.

- ④ Swing the nail guide closed.

- (6) Lock the knob completely.

The Nailer is now ready to operate.

NAILER OPERATION

Read section titled "SAFETY" (pages 4—6).

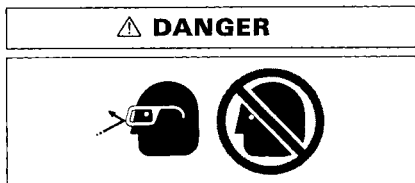

- **Always wear eye protector.**

⚠ WARNING

- **Never point Nailer toward yourself or anyone else.**
- **Never carry with finger on trigger. Remove finger from trigger when not driving nails.**
- **Never place your hands or feet closer than 8 inches from firing head when using.**
- **Do not drive nails on top of other nails or with Nailer at too steep of an angle; nails can ricochet and hurt someone.**
- **In order to avoid double fire,**
 - 1) **do not push Nailer on workpiece with strong force;**
 - 2) **take Nailer away from workpiece using recoil;**
 - 3) **release trigger quickly when performing trigger fire.**
- **Do not drive nails into thin boards or near corners and edges of workpiece. Nails can be driven through or away from workpiece and hit someone.**
- **Never drive nails from both sides of a wall at the same time. Nails can be driven into and through the wall and hit a person on the opposite side.**
- **Never use Nailer which is defective or operating abnormally.**
- **Do not use Nailer as hammer.**
- **Disconnect air hose from Nailer when:**
 - 1) **it is not in use;**
 - 2) **leaving work area;**
 - 3) **moving it to another location; and**
 - 4) **handing it to another person.**

NOTE:

- Be careful that the final nail can be dropped or driven at an irregular angle.

METHODS OF OPERATION

This Nailer is equipped with the push lever and does not operate unless the push lever is depressed (upward position).

There are two methods of operation to drive nails with this Nailer.

They are:

1. Intermittent operation (Trigger fire);
2. Continuous operation (Push lever fire);

(1) Intermittent operation (Trigger fire)

- ① Position the nail outlet on the workpiece with finger off the trigger.
- ② Depress the push lever firmly until it is completely depressed.
- ③ Pull the trigger to drive a nail.
- ④ Remove finger from the trigger.

To drive another nail, move the Nailer along the workpiece and repeat this procedure.

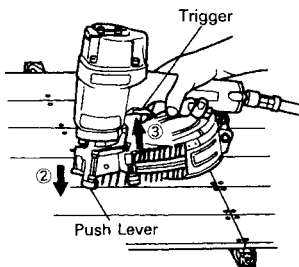

(2) Continuous operation (Push lever fire)

- ① Pull the trigger with the Nailer off the workpiece.
- ② Depress the push lever against the workpiece to drive a nail.
- ③ Move the Nailer along the workpiece with a bouncing motion.
Each depression of the push lever will drive a nail.

As soon as the desired number of nails have been driven, remove finger from the trigger.

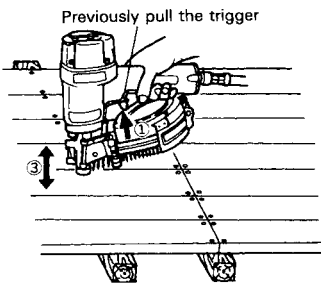

NOTE:

- Always handle nails and package carefully. If nails are dropped, collating plastic may be broken, which will cause un-feeding. In this case, load nails into the Nailer again.
- After nailing:
 - 1) disconnect air hose from the Nailer;
 - 2) remove all nails from the Nailer;
 - 3) supply 2—3 drops of Hitachi pneumatic tool lubricant into the air plug on the Nailer; and
 - 4) open the petcock on the air compressor tank to drain any moisture.

MAINTENANCE

NOTE:

The information contained in this Manual is designed to assist you in the safe maintenance of the Nailer.

Some illustrations in this Manual may show details or attachments that differ from those on your own Nailer.

MAINTENANCE AND INSPECTION

Read section titled "SAFETY" (pages 4–6).

⚠ WARNING

- **Disconnect air hose and remove all nails from Nailer when:**
 - 1) **doing maintenance and inspection ; and**
 - 2) **clearing a jam.**

1. Inspecting the feeders

① DISCONNECT AIR HOSE.

② Clean the knob sliding part.

Lubricate it with Hitachi pneumatic tool lubricant.

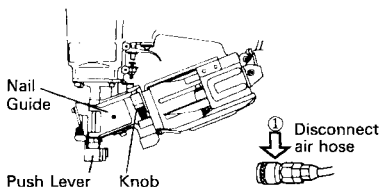

③ Open the nail guide and remove dust.

Lubricate the nose opening and feeder shaft.

⚠ CAUTION

- **Check that the main nail stopper, sub nail stopper, main feeder and sub feeder slide smoothly by pushing them with finger. If not smooth, nails can be driven at an irregular angle and hurt someone.**

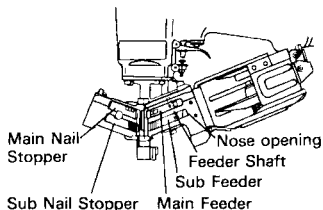

④ Lubricate the feeding surfaces of the nose and the nail guide after cleaning.

This promotes smooth operation and prevents rust.

2. Storing

- When not in use for an extended period, apply a thin coat of the lubricant to the steel parts to avoid rust.
- Do not store the Nailer in a cold weather environment. Keep the Nailer in a warm area.
- When not in use, the Nailer should be stored in a warm and dry place.
- Keep out of reach of children.

3. WARNING LABEL

Change the WARNING LABEL if missing or damaged. A new WARNING LABEL is available from a Hitachi authorized service center.

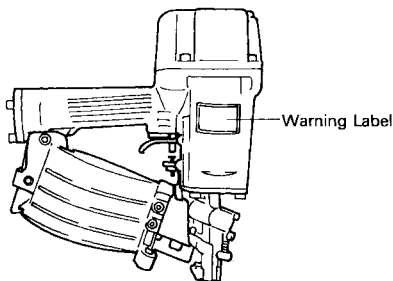

4. Maintenance chart (See page 15.)

5. Operator troubleshooting (See page 15.)

SERVICE AND REPAIRS

⚠ WARNING

- **Only service personnel trained by Hitachi, distributor or employer shall repair the Nailer.**
- **Use only parts supplied or recommended by Hitachi for repair.**

All quality Nailers will eventually require servicing or replacement of parts because of wear from normal use.

NOTE:

Specifications are subject to change without any obligation on the part of HITACHI.

Maintenance chart

ACTION	WHY	HOW
Drain air line filter daily.	Prevent accumulation of moisture and dirt.	Open manual petcock.
Keep lubricator filled.	Keep the Nailer lubricated.	Fill with Hitachi pneumatic tool lubricant.
Clean filter element — then blow air through filter in direction opposite to normal flow.	Prevent clogging of filter with dirt.	Follow manufacturer's instructions.
Clean magazine and feeder mechanism.	Prevent a jam.	Blow clean daily.
Keep push lever working properly.	Promote operator safety and efficient Nailer operation.	Blow clean daily.
Lubricate the Nailer after nailing.	Extend the Nailer life.	Supply 2 — 3 drops of lubricant into the Nailer.
Drain air compressor.	Keep the Nailer operated properly.	Open petcock on air compressor tank.

Operator troubleshooting

Most minor problems can be resolved quickly and easily using the table below.
If problems persist, contact a Hitachi authorized service center for assistance.

PROBLEM	CHECK METHOD	CORRECTION
Nailer operates, but no nail is driven.	Open nail guide. Check for a jam.	Clear a jam.
	Check collating plastic for breakage.	Feed nails.
	Check for proper nails.	Use only recommended nails.
	Check function of feeder per page 14.	Clean and lubricate.
Weak drive. Slow to cycle.	Check air pressure.	Increase air pressure. (Do not exceed 120 psi(8.3 bar 8.5kgf/cm ²))
	Driver blade worn ?	Contact Hitachi for replacement.
	Piston O-ring worn or damaged ?	
Drives too deep.	Use Hitachi pneumatic tool lubricant.	
	Check air pressure.	Reduce air pressure. (Adjust 70 — 120 psi)
Skipping nails. Intermittent feed.	Check for proper nails.	Use only recommended nails.
	Check function of feeder per page 14.	Clean and lubricate.
	Use Hitachi pneumatic tool lubricant.	
	Piston O-ring cut or heavily worn ?	Contact Hitachi for replacement.
Drives properly during normal operation, but does not drive fully at faster nailing speeds.	Check inside diameter of air hose.	Use larger air hose.

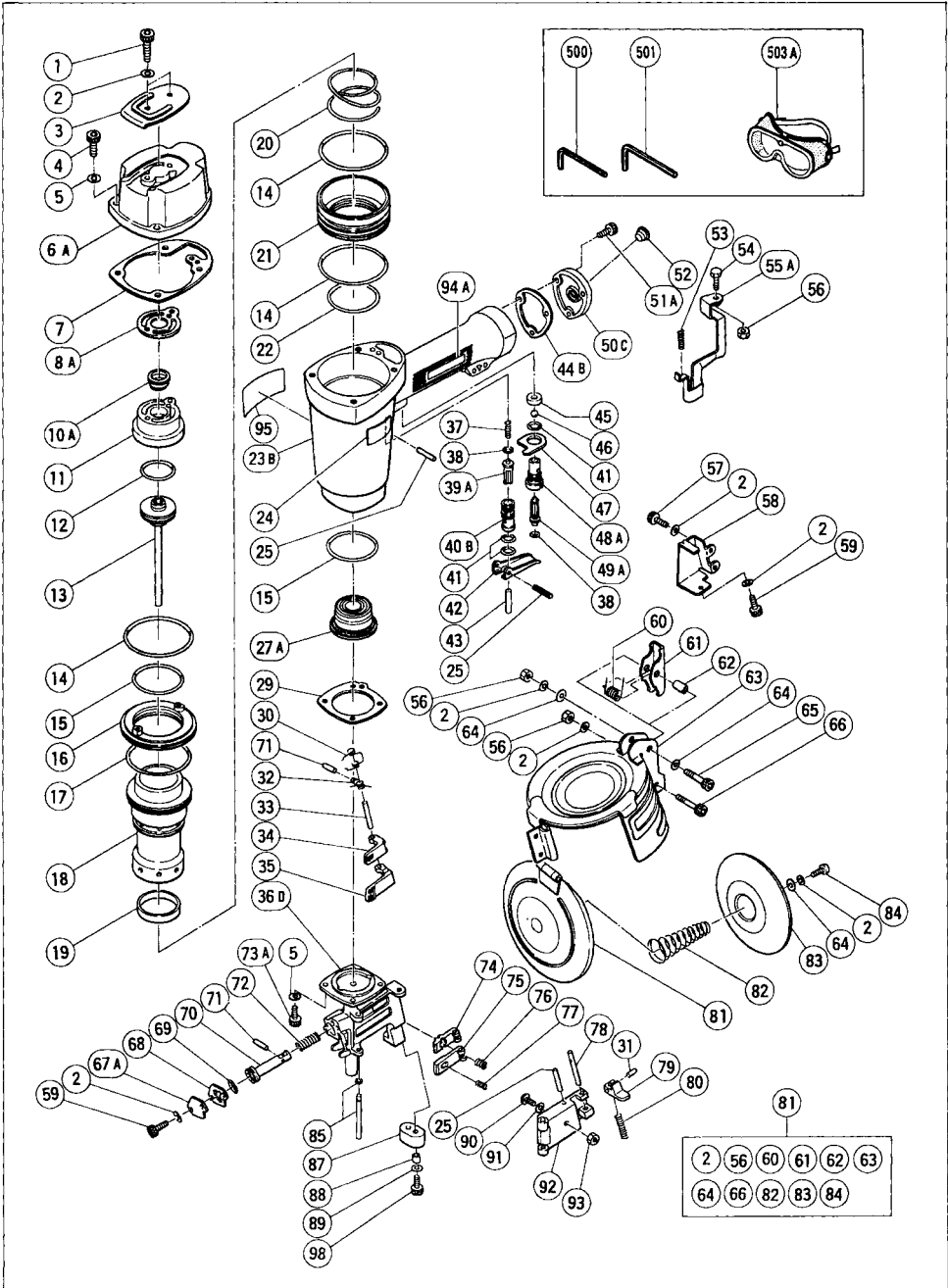

VH-650

Item No.	Code No.	Part Name	Q'ty
1	949-822	Hexagon Socket Hd. Bolt M5×35	2
2	949-454	Spring Washer M5	10
3	876-444	Top Cover	1
4	949-652	Hexagon Socket Hd. Bolt M6×25	4
5	949-455	Spring Washer M6	8
6A	876-769	Exhaust Cover (D)	1
7	876-747P	Gasket (F)	1
8A	876-749	Gasket (G)	1
10A	878-417	Exhaust Valve	1
11	876-748P	Head Cap (D)	1
12	931-835	O-ring (P36)	2
13	876-734	Piston	1
14	874-104	Cylinder O-ring (I. D. 68.3)	3
15	875-602	Cylinder O-ring (I. D. 50.9)	2
16	876-435	Cylinder Plate	1
17	877-312	Cylinder O-ring (I. D. 63.1)	1
18	876-732	Cylinder	1
19	876-434	Cylinder Ring	1
20	875-605	Cylinder Spring	1
21	876-731	Cylinder Guide	1
22	876-433	Cylinder O-ring (B)	1
23B	876-759	Body Cap Ass'y	1
24	976-757Z	Nameplate	1
25	949-866	Roll Pin D3×30	3
27A	876-766	Piston Bumper (A)	1
29	876-737	Gasket (A)	1
30	876-712	Main Feeder Spring (A)	1
31	949-776	Roll Pin D3×10	1
32	876-691	Sub Feeder Spring	1
33	876-689	Feeder Shaft	1
34	876-688	Main Feeder	1
35	876-707	Sub Feeder	1
36D	876-752	Nose Ass'y	1
37	875-643	Plunger Spring	1
38	874-820	Plunger O-ring	2
39A	878-122	Plunger (A)	1
40B	878-266	Valve Bushing	1
41	875-638	O-ring (S-12)	3
42	876-203	Trigger	1
43	875-642	Safety Plunger (B)	1
44B	877-331	Gasket (D)	1
45	875-637	Valve Packing	1
46	875-645	Urethane Ball (B) D7.14	1
47	875-644	Valve Plate	1
48A	877-335	Trigger Valve Bushing	1
49A	878-121	Trigger Plunger	1
50C	878-311	Cap	1
51A	949-457	Hexagon Socket Hd. Bolt M5×18	3
52	872-035	Dust Cap	1
53	876-676	Safety Spring	1
54	875-650	Safety Bolt	1
55A	876-763	Push Lever (G)	1
56	949-555	Nut M5	3
57	949-765	Hexagon Socket Hd. Bolt M5×12	2
58	876-696	Safety Guard	1
59	949-819	Hexagon Socket Hd. Bolt M5×10	3
60	876-703	Magazine Lock Spring	1
61	876-702	Magazine Stopper	1
62	876-743	Collar	1
63	876-742	Magazine Primary	1

Item No.	Code No.	Part Name	Q'ty
64	876-205	Washer	3
65	949-664	Hexagon Socket Hd. Bolt M5×30	1
66	949-662	Hexagon Socket Hd. Bolt M5×25	1
67A	876-661	Feed Piston Cover	1
68	876-695	Gasket (E)	1
69	873-095	O-ring (P-16)	1
70	876-692	Feed Piston	1
71	949-551	Roll Pin D2.5×10	2
72	876-693	Feed Spring	1
73A	877-947	Nylock Hex. Socket Hd. Bolt M6×20	4
74	877-143	Main Nail Stopper	1
75	876-679	Sub Nail Stopper	1
76	876-681	Main Stopper Spring	1
77	876-685	Sub Stopper Spring	1
78	876-682	Lock Shaft	1
79	877-374	Guide Lock	1
80	877-372	Spring	1
81	876-741	Magazine Ass'y	1
82	876-701	Holder Spring	1
83	876-700	Nail Holder	1
84	876-705	Hexagon Socket Hd. Screw M5×10	1
85	876-760	Nail Guide Shaft (A)	1
87	876-697	Guard Bumper	1
88	876-706	Bumper Collar	1
89	949-431	Bolt Washer M5	1
90	876-680	Stopper Bolt	1
91	876-686	Thrust Washer	2
92	876-677	Nail Guide	1
93	874-780	Nylon Nut M3	1
94A	878-312	HITACHI Label	1
95	878-184	Warning Label	1
98	949-665	Hexagon Socket Hd. Bolt M5×14	1
500	944-458	Allen Wrench 4mm	1
501	944-459	Allen Wrench 5mm	1
503A	875-769	Eye Protector	1

Parts are subject to change without any obligation on the part of the HITACHI due to improvements.

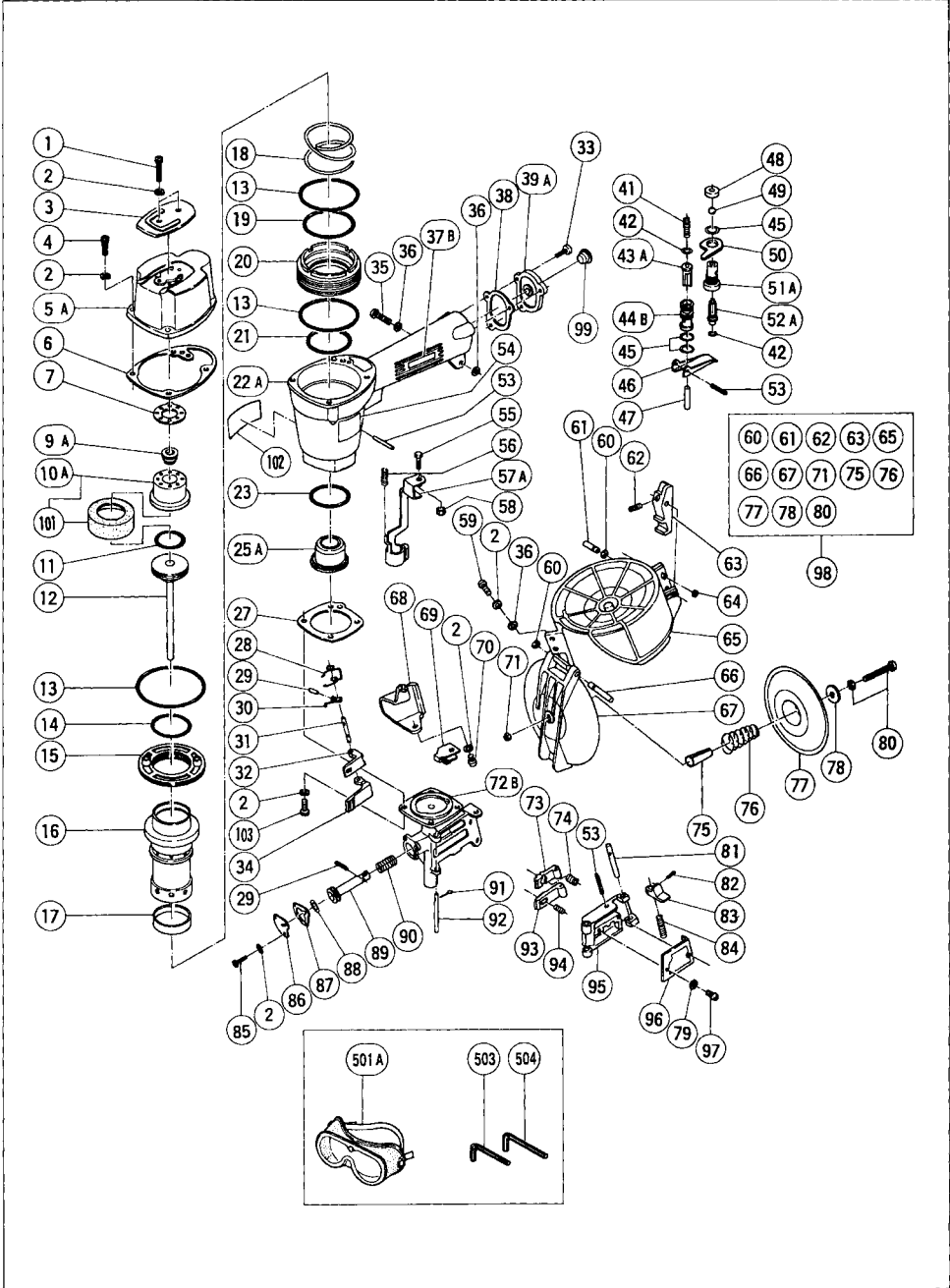

NV50AA

Item No.	Code No.	Part Name	Q'ty
1	949-662	Hexagon Socket Hd. Bolt M5×25	2
2	949-454	Spring Washer M5	15
3	876-179	Top Cover	1
4	949-757	Hexagon Socket Hd. Bolt M5×20	4
5A	880-275	Exhaust Cover (B)	1
6	876-712P	Gasket (F)	1
7	876-713P	Gasket (G)	1
9A	878-417	Exhaust Valve	1
10A	876-711P	Head Cap (B)	1
11	876-174	Piston O-ring	1
12	877-127	Piston	1
13	876-161	O-ring (S65)	3
14	877-126	Cylinder O-ring (D)	1
15	876-168	Cylinder Plate	1
16	876-632	Cylinder	1
17	876-167	Cylinder Ring	1
18	876-172	Cylinder Spring	1
19	877-123	Cylinder O-ring (A)	1
20	877-122	Cylinder Guide	1
21	877-124	Cylinder O-ring (B)	1
22A	876-709P	Body (B)	1
23	877-125	Cylinder O-ring (C)	1
25A	878-359	Piston Bumper	1
27	876-673	Gasket (A)	1
28	876-717	Main Feeder Spring (A)	1
29	949-551	Roll Pin D2.5×10	2
30	876-691	Sub Feeder Spring	1
31	876-689	Feeder Shaft	1
32	876-688	Main Feeder	1
33	949-821	Hexagon Socket Hd. Bolt M5×16	4
34	876-707	Sub Feeder	1
35	949-242	Machine Screw M5×22	1
36	876-205	Washer	4
37B	878-182	HITACHI Label	1
38	877-131	Gasket (D)	1
39A	880-036	Cap	1
41	875-643	Plunger Spring	1
42	874-820	Plunger O-ring	2
43A	878-122	Plunger (A)	1
44B	878-266	Valve Bushing	1
45	875-638	O-ring (S12)	3
46	876-203	Trigger	1
47	875-642	Plunger (B)	1
48	875-637	Valve Packing	1
49	875-645	Urethane Ball (B) D7.14	1
50	875-644	Valve Plate	1
51A	877-335	Trigger Valve Bushing	1
52A	878-121	Trigger Plunger	1
53	949-866	Roll Pin D3×30	3
54	306-867	Nameplate	1
55	875-650	Bolt	1
56	876-676	Spring	1

Item No.	Code No.	Part Name	Q'ty
57A	877-941	Push Lever (G)	1
58	949-555	Nut M5	1
59	949-240	Machine Screw M5×18	2
60	872-971	Retaining Ring (E-Type)For D3 Shaft	2
61	877-150	Stopper Pin	1
62	877-149	Stopper Spring	1
63	877-151	Magazine Stopper	1
64	945-255	U-Nut M5	1
65	877-146	Magazine	1
66	877-152	Hinge Pin	1
67	877-147	Magazine Cover	1
68	877-138	Guard	1
69	877-145	Guard Washer	1
70	949-237	Machine Screw M5×12	1
71	876-465	Nylon Nut M4	1
72B	877-946	Nose Ass'y	1
73	877-143	Main Nail Stopper	1
74	876-681	Main Stopper Spring	1
75	877-148	Sleeve	1
76	877-141	Holder Spring	1
77	877-140	Nail Holder	1
78	875-249	Thrust Washer	1
79	949-453	Spring Washer M4	2
80	986-120	Machine Screw(W/Sp. Washer) M4×40	1
81	876-682	Lock Shaft	1
82	949-776	Roll Pin D3×10	1
83	877-374	Guide Lock	1
84	877-372	Spring	1
85	876-705	Hexagon Socket Set Screw M5×10	2
86	877-136	Feed Piston Cover	1
87	877-137	Gasket (E)	1
88	873-095	O-ring (P-16)	1
89	876-692	Feed Piston	1
90	877-144	Feed Spring	1
91	877-826	Feeder Shaft Ring	1
92	876-716	Nail Guide Shaft (A) Ass'y	1
93	876-679	Sub Nail Stopper	1
94	876-685	Sub Stopper Spring	1
95	877-134	Nail Guide	1
96	877-135	Nail Guide Cover	1
97	949-214	Machine Screw M4×6	2
98	877-139	Magazine Ass'y	1
99	872-035	Dust Cap	1
102	878-184	Warning Label	1
101	877-942	Head Cap Rubber	1
103	878-181	Nylock Hex. Socket. Hd. Bolt M5×16	4
501A	875-769	Eye Protector	1
503	943-277	Allen Wrench 3mm	1
504	944-458	Allen Wrench 4mm	1

Parts are subject to change without any obligation on the part of the HITACHI due to improvements.

Hitachi Koki Co.,Ltd.

Nippon Bldg., 6-2, Ohtemachi 2-chome,

Chiyoda-ku, Tokyo 100, Japan

412

Code No. C99067261 A
Printed in Japan
